

KEY FEATURES

- High-end mini linear LED downlight
- IP44 luminaire with a wide range of options
- Samsung high power, high efficiency LEDs
- Ra90 high colour rendering
- Injection moulded low glare, matt black baffle
- High clarity 30° medium beam lenses
- Long life >60,000h L80
- Available with efficacies over 100 lm/tcW
- 5 year warranty

DIMENSIONS

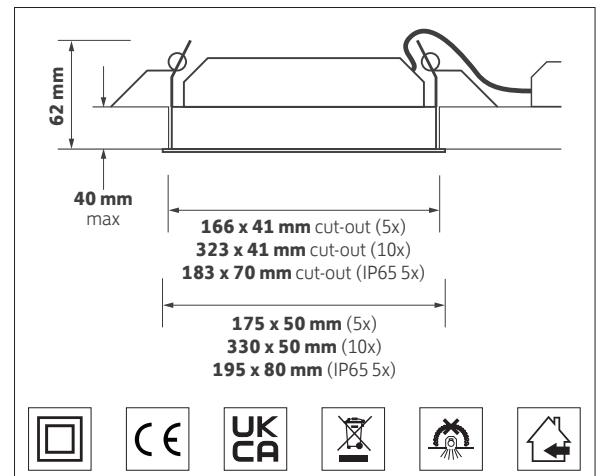

ORDERING INFORMATION

Lenses	Luminaire output (lm)	Luminaire power (tcW)	Colour	Model ref.
5x	525	7	930	AFE001/LO
5x	525	7	940	AFE002/LO
5x	1050	13	930	AFE001
5x	1050	13	940	AFE002
10x	1050	13	930	AFE003/LO
10x	1050	13	940	AFE004/LO
10x	2100	23	930	AFE003
10x	2100	23	940	AFE004

OPTIONS

Options	Suffix
White baffles	/WH
Gold baffles	/GD
Black bezel RAL 9005	/BK
Grey bezel RAL 9006	/GY
10° super narrow beam lenses	/SNB
15° narrow beam lenses	/NB
50° wide beam lenses	/WB
Plaster-in trimless bezel	/PI
TouchDIM & DALI control gear	/T+DALI
Casambi wireless network (inc dimming)	/BTC
Emergency - Remote indicator	/EM
DALI emergency - Remote indicator	/EMD
IP65 sealed (5x only)	/65



/WH
White baffles

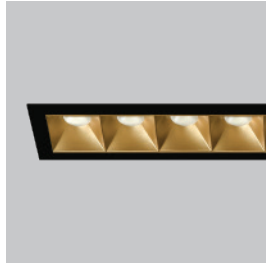

/GD
Gold baffles

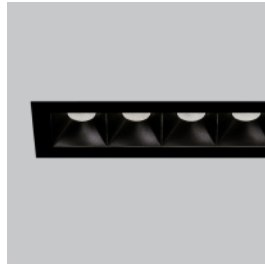

/BK
Black bezel



/BK
Black bezel

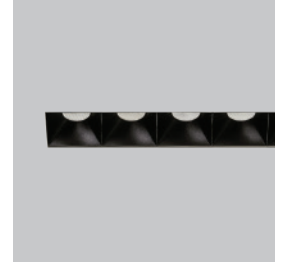

/PI
Plaster-in trimless bezel



/SNB
10° super narrow
beam lenses



/NB
15° narrow
beam lenses



/WB
50° wide
beam lenses



/T+DALI
TouchDIM and DALI



/BTC
Casambi wireless network
inc. dimming

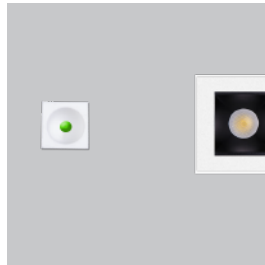

/EM
Emergency
Remote indicator

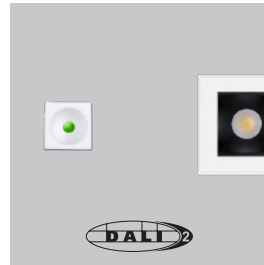

/EMD
DALI emergency
Remote indicator



/65
IP65 sealed
(5x only)



BTWS001
Wireless Casambi
single wall switch



BTWS002
Wireless Casambi
twin wall switch



Quinto - AFE

Options & accessories



Membership No 1835

PV - PRODUCT VARIATIONS

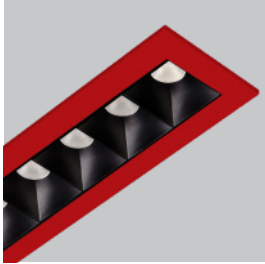

Any RAL colour bezel
PV - Contact Sales

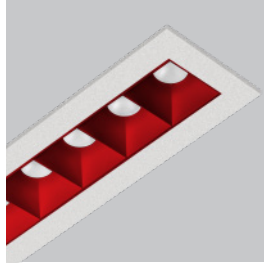

Any RAL colour baffles
PV - Contact Sales

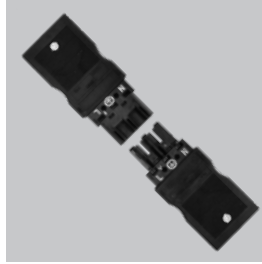

Plug & Play
Choice of connectors
PV - Contact Sales

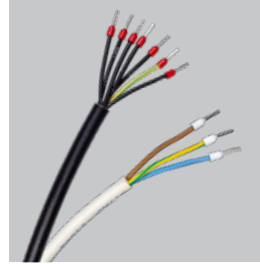

LS0H / LSF cables
PV - Contact Sales

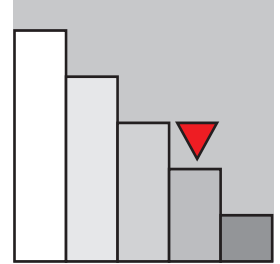

Specific outputs
PV - Contact Sales



Surface mount
PV - Contact Sales



Track mount
PV - Contact Sales



Suspended
PV - Contact Sales

RELATED PRODUCTS



Adjustable version
See AFF

Thornhill Road Business Park
Tenter Fields, Dewsbury
West Yorkshire
WF12 9QT
+44 (0)1924 482777
www.gamma-uk.com



Please note: Specification values may change due to rapid development of lighting technology. All performance data is taken at an ambient temperature of +25°C. Data may be rounded up/down for illustrative purposes. We reserve the right to amend or change details without prior notification. E&OE.