

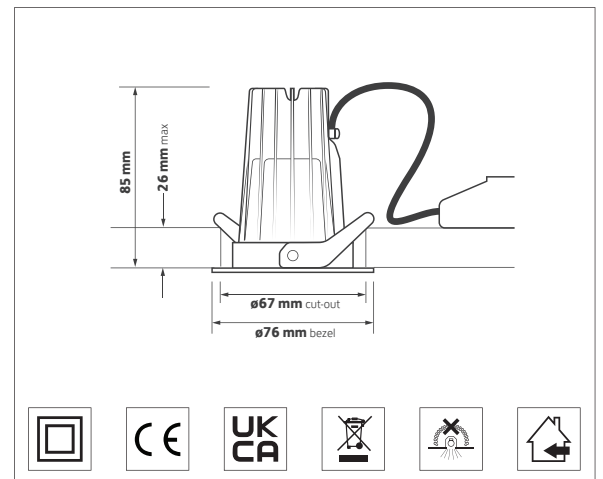

KEY FEATURES

- Miniature architectural LED downlight
- Tridonic SLE Advanced LED engine and driver system
- Multi-facet 40° injection moulded reflector
- Lumen maintenance L80/F10 @ >60,000h
- 3 step MacAdam ellipse (SDCM)
- Die-cast bezel finished in white RAL 9016
- DALI, wireless and emergency options
- 5 year warranty

DIMENSIONS



ORDERING INFORMATION

Luminaire output (lm)	Colour	Luminaire power (tcW)	Light source efficacy (lm/W)	Luminaire efficacy (lm/tcW)	Model ref.
550	927	7.5	139	75	AGJ001
575	830	6.0	177	95	AGJ002
600	840	6.0	188	100	AGJ003
725	927	9.5	134	75	AGJ004
750	830	7.5	174	100	AGJ005
775	840	7.5	180	105	AGJ006

Note: Equivalent 50W Philips halogen lamp = 470 lm

OPTIONS

Options	Suffix
Control gear	/MDIM, /ECO, /BTC
Emergency - Remote indicator	/EM, /EMD, /EMM
Body type	/T, /BL, /BLT
Reflector narrow beam	/NB
High colour rendering	/9

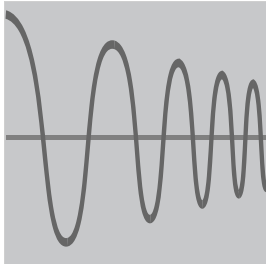

/MDIM

Phase-cut mains dimming

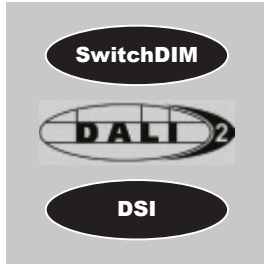

/ECO

SwitchDIM / DALI / DSI

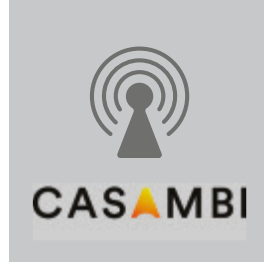

/BTC

Casambi wireless network inc. dimming



/EM

Emergency Remote indicator

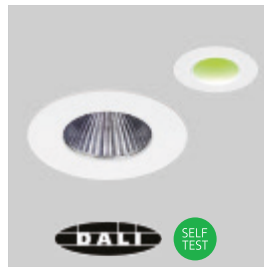

/EMD

DALI / Self test EM Remote indicator



/EMM

Wireless mesh EM Remote indicator



/T

Tilt



/BL

Black RAL 9005



/BLT

Tilt
Black RAL 9005



/NB

20° reflector



/R9

High colour rendering LED module

RELATED PRODUCTS



See Note AGA
Tridonic SLA



See Note AGB
Tridonic SLA



See Note AGE
Tridonic SLE

PV - PRODUCT VARIATIONS



PV - Contact Sales
Choice of connectors

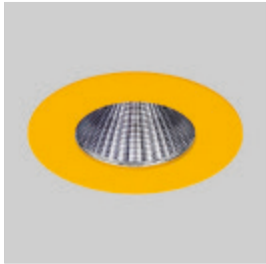

PV - Contact Sales
Any RAL colour bezel

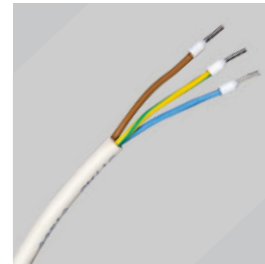

PV - Contact Sales
LSOH / LSF cable