

### KEY FEATURES

- Professional, high performance LED downlight
- Available with a wide range of options and accessories
- Tridonic SLE LED module and driver system
- Minimalist die-cast bezel in brilliant white RAL 9016
- Low glare multi-faceted 55° aluminium reflector
- Up to 139 luminaire lumens per total circuit Watt
- Nominal rated life 55,000h L90
- CIBSE TM66 Assessment: "Excellent circularity"
- MacAdam colour tolerance <3 SDCM
- 5 year warranty

### DIMENSIONS

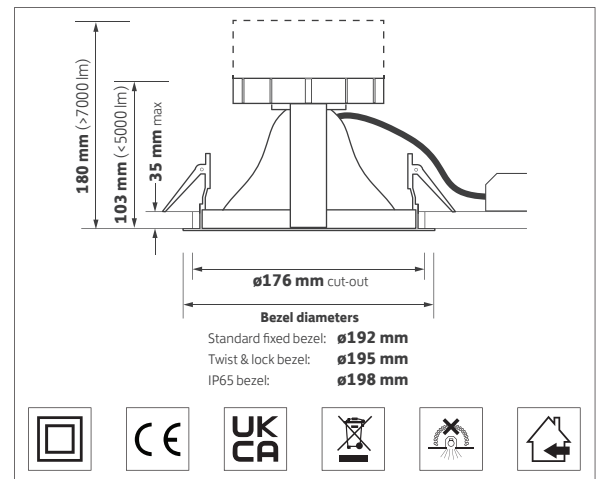

### ORDERING INFORMATION

Luminaire output (llm)	Colour temp	Luminaire power (tcW)	Light source efficacy (lm/W)	Luminaire efficacy (llm/tcW)	Model ref.
1200	830	9.0	197	133	<b>AA001</b>
1250	840	9.0	207	139	<b>AA002</b>
1875	830	14.5	196	129	<b>AA003</b>
1975	840	14.5	204	136	<b>AA004</b>
3200	830	24.5	185	131	<b>AA005</b>
3325	840	24.5	194	136	<b>AA006</b>
4625	830	37.0	172	125	<b>AA007</b>
4825	840	37.0	180	130	<b>AA008</b>
7900	830	65.5	166	111	<b>AA009 (/TL or /65)</b>
8250	840	65.5	173	116	<b>AA010 (/TL or /65)</b>
10,025*	830	94.5	144	98	<b>AA011 (/TL or /65)</b>
10,300*	840	94.5	148	101	<b>AA012 (/TL or /65)</b>

\* Bridgelux LED module

### OPTIONS

Options	Suffix
Satin etched reflector	<b>/SA65</b>
High colour rendering LED	<b>/R9</b>
IP54 sealed clear lens	<b>/54</b>
Control gear	<b>/ECO, /TOP, /BTC</b>
Emergency - Remote indicator	<b>/EM, /EMD, /EMM</b>
Emergency - Integral indicator	<b>/EMI, /EMDI, /EMMI</b>
Twist & lock bezel option	<b>/TL</b>
IP65 bezel option	<b>/65</b>
Product variations available	<b>PV.</b>

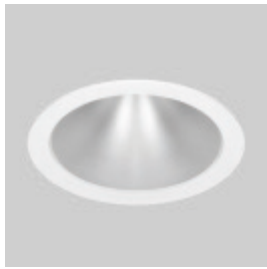

**/SA65**  
65° satin etched  
reflector



**/R9**  
High colour rendering  
LED module



**/54**  
IP54 sealed  
clear lens\*\*

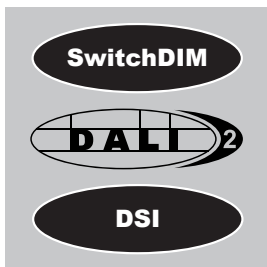

**/ECO**  
SwitchDIM, DALI & DSI

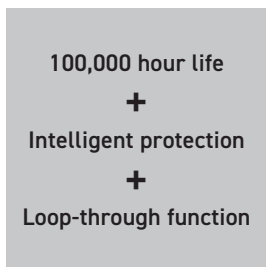

**/TOP**  
Tridonic Excite  
Series driver \*\*

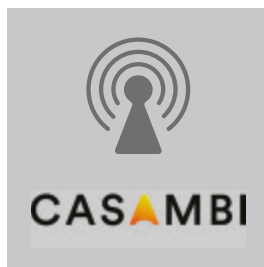

**/BTC**  
Casambi wireless network  
inc. dimming \*\*



**/EM**  
Emergency  
Remote indicator

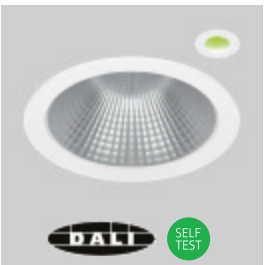

**/EMD**  
DALI / Self test EM  
Remote indicator



**/EMM**  
Wireless mesh EM  
Remote indicator

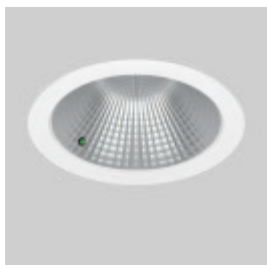

**/EMI**  
Emergency  
Integral indicator

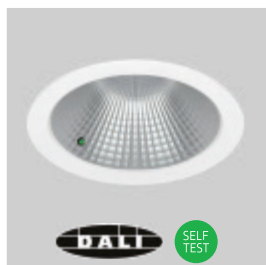

**/EMDI**  
DALI / Self test EM  
Integral indicator

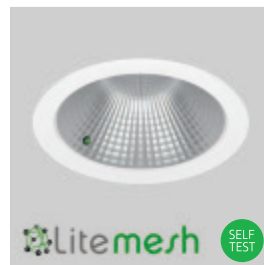

**/EMMI**  
Wireless mesh EM  
Integral indicator

\*\* Not available with 009 - 012

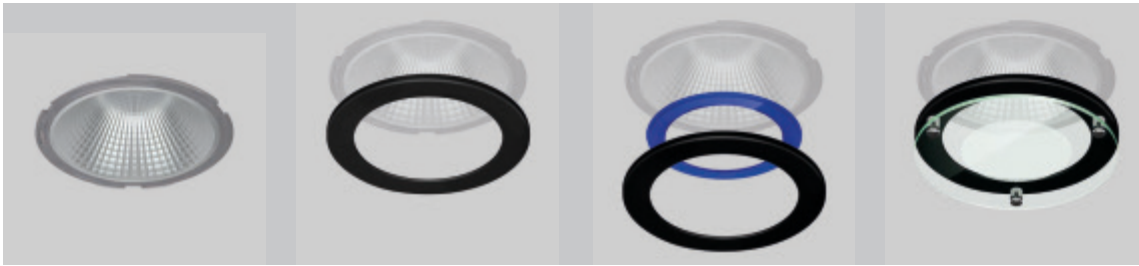

**/TL**  
Twist & lock bezel  
option

**Bezel**

**Bezel + accessory**

**Dropped glass bezel**

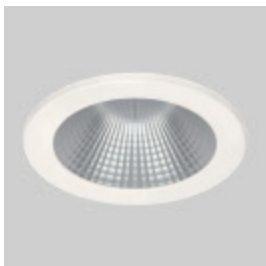

**TA300/WH**  
White bezel  
RAL 9010



**TA300/BWH**  
Brilliant white bezel  
RAL 9016



**TA300/BL**  
Black bezel  
RAL 9005



**TA300/GY**  
Grey bezel  
RAL 9006



**TA310/FROST**  
Frosted snoot

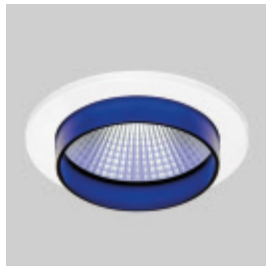

**TA310/BLUE**  
Blue snoot



**PV - Contact Sales**  
Black snoot RAL 9005



**TA384**  
Frost hi-light

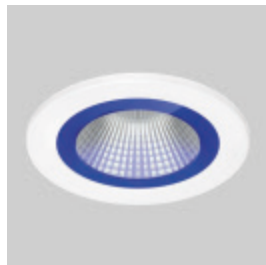

**TA385**  
Blue hi-light



**TA340**  
IP54 sealed  
clear glass



**TA341**  
IP54 sealed  
centre etched glass



**TA342**  
IP54 sealed  
fully etched glass

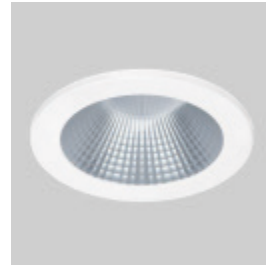

**TA343**  
IP54 sealed  
clear polycarbonate\*\*



**TA344**  
IP54 sealed  
opal polycarbonate\*\*



**TA317**  
IP44 sealed  
prismatic lens\*\*



**TA301**  
Dropped glass bezel  
c/w outer etched glass



**TA302**  
Dropped glass bezel  
c/w clear glass



**TA303**  
Dropped glass bezel  
c/w centre etched glass



**TA305**  
Dropped glass bezel  
c/w clear halo glass



**TA306**  
Dropped glass bezel  
c/w etched halo glass



**TA307**  
Dropped glass bezel  
c/w etched glass



**/65**  
IP65 option



**Bezel + lens**



**IP65/002/195**  
White IP65 bezel  
Clear glass



**IP65/008/195**  
White IP65 bezel  
Opal polycarbonate\*\*



**IP65/009/195**  
White IP65 bezel  
Clear polycarbonate\*\*

\*\* Not available with 009 - 012

## PV - PRODUCT VARIATIONS

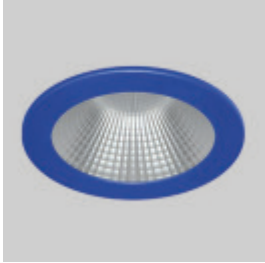

**PV - Contact Sales**  
Any RAL colour  
twist & lock / IP65 bezel



**PV - Contact Sales**  
Choice of connectors

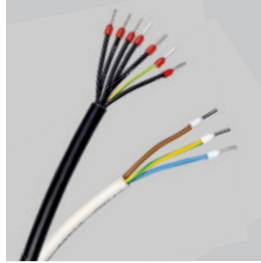

**PV - Contact Sales**  
LSOH / LSF cable

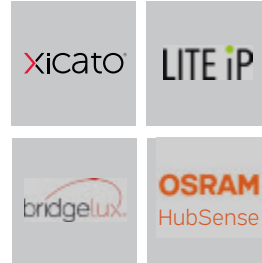

**PV - Contact Sales**  
Choice of modules

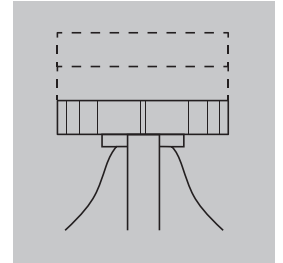

**PV - Contact Sales**  
High ambient  
temperatures

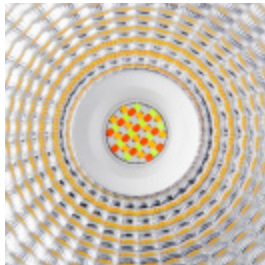

**PV - Contact Sales**  
RGBW colour change

## RELATED PRODUCTS



**See Great White**  
130mm downlights

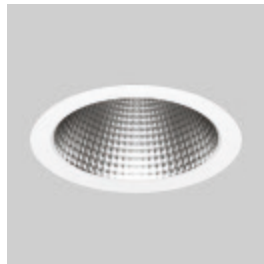

**See Titan**  
240mm downlights



**See Aspen**  
IP54 downlights



**See Sysion SRE**  
Surface / suspended  
downlights



**GF008 / GF010**  
Anti-tamper driver  
Anti-tamper bit