

INSTALLATION GUIDE:

LED DOWNLIGHT
990.0275.01



IMPORTANT:

The luminaire must not be covered by any debris or insulating material. Ensure there is a minimum of 50 mm airspace around the luminaire and control gear. Electrical termination must be carried out by a qualified electrician in accordance with the latest edition of IEE wiring regulations BS7671.

NOTE: THE LED MODULES IN THIS LUMINAIRE ARE NON-USER REPLACEABLE.

PLEASE RETAIN THIS GUIDE FOR FUTURE REFERENCE AND RECYCLE PACKAGING.

A



ISOLATE MAINS SUPPLY BEFORE COMMENCING INSTALLATION



ø81 mm



81 x 81 mm



145 x 81 mm



213 x 81 mm

- Round - cut an ø81 mm circular hole at the desired location using a suitable holesaw.
- Square - cut an 81 mm by 81 mm square hole at the desired location.
- Twin - cut a 145 mm by 81 mm rectangular hole at the desired location
- Triple - cut a 213 mm by 81 mm rectangular hole at the desired location

B

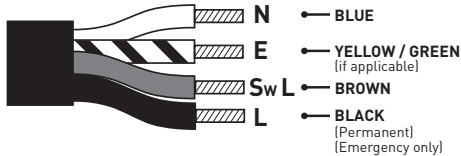

- Connect the luminaire to the mains supply using a terminal block (not supplied) compliant with the requirements of EN60998-2-1 or 2-2.
- For Touch & Dim or DALI wiring see instruction leaflet 990.0009.01.

C

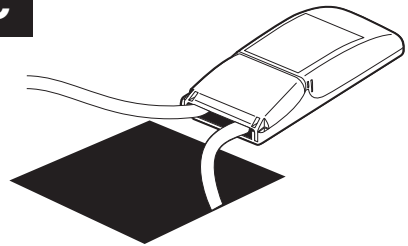

- Feed the driver(s) into the ceiling void, ensuring it is not covered by any debris or insulating material and is correctly positioned.

D

Note:
Luminaire style may vary

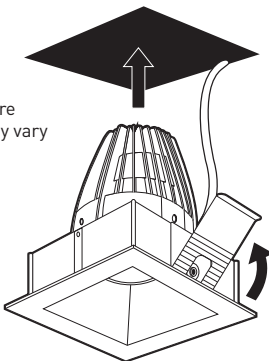

- Squeeze in ceiling springs and push the luminaire up into the ceiling void.

- Once in place make sure the luminaire is secure in ceiling.

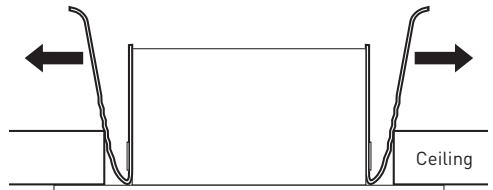

REINSTATE MAINS SUPPLY