

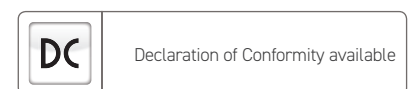

Key Features

- 600 x 600 lay-in LED panel powered by Tridonic
- Low glare UGR <19 for LG7 compliance
- Part L and ETL compliant efficacies
- Lumen maintenance up to L80/F10 @ 50,000 hours
- Self-extinguishing TP(a) diffuser option
- DALI, dimming and EM options
- 5 year warranty

Technical Drawing

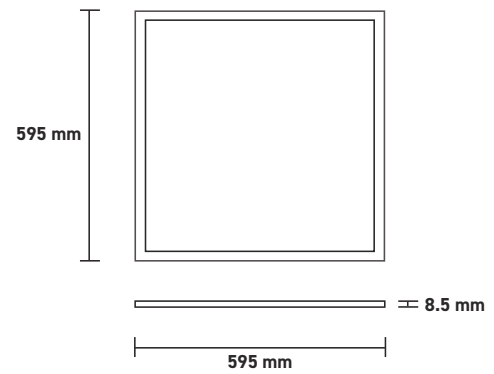

Ordering Information

Luminaire Output (lm)	Power (tcW)	Colour	Model Ref.
2700	26.5	830	AGH001
3100	26.0	840	AGH002
3600	36.5	830	AGH003
3900	34.5	840	AGH004

Options

TP(a) diffuser	/TPA
SwitchDIM, DALI or DSI	/ECO
100,000 hr Tridonic Excite driver	/TOP
Emergency conversion	/EM
DALI emergency	/EMD
Casambi Bluetooth wireless network (inc. dim)	/BTC
Surface mounting kit	SURF.178
Suspension kit	SUS.178/1.2M
Plasterboard fixing kit	PBF.178

Options

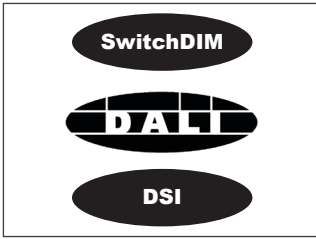

/ECO
SwitchDIM + DALI + DSI



/TPA
TP(a) diffuser



/TOP
Tridonic Excite Driver - 100K hours
I-Select, Loop in - loop out

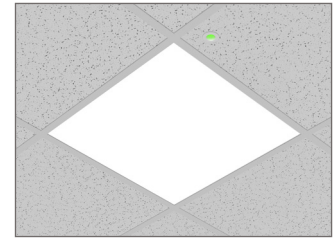

/EM
3 hour EM

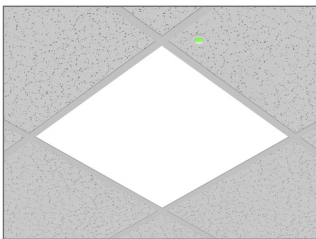

/EMD
DALI 3 hour EM conversion



SURF.178
Surface mount frame



PBF.178
Plasterboard mounting kit

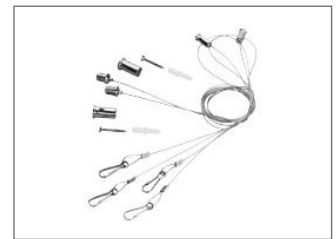

SUS.178.1.2M
Wire suspension kit

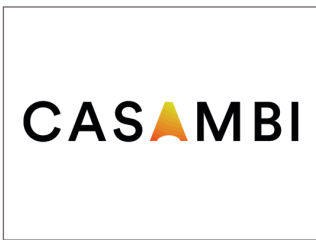

/BTC
Casambi Bluetooth wireless
network (inc. dim)