

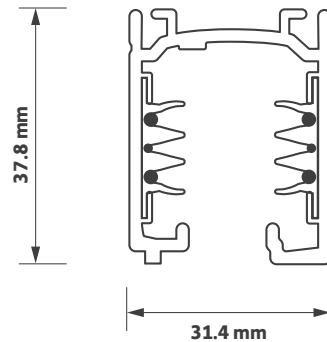







Key Features

- Surface mounted lighting track system
- Based on the Eurostandard Plus® platform
- Suitable for use with Global Trac® adaptors
- Three circuit and DALI compatible
- An easy to create and design modular system
- Available in black or white

Technical Drawing



Ordering Information

Description	Model Ref. - White	Model Ref. - Black
1 m track	9000-1/W-ST	9000-1/B-ST
2 m track	9000-2/W-ST	9000-2/B-ST
End feed 	9001/W	9001/B
Straight connector 	9003/W	9003/B
End cap 	9004/W	9004/B
L-connector / feed 	9011/W	9011/B
Flexible adjustable corner connector 	9018/W	9018/B
2 m wire suspension kit 	S-9000/114-T/W	S-9000/114-T/B
Patress 	9000/BP-D-W	9000/BP-D-B

Options

Please select from the options below.

Conductor cutting tool  S-9000/T

For a wider range of track and accessories, please contact our sales team.



Maximum Load

1 m Track

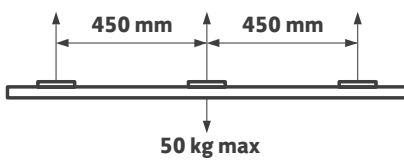
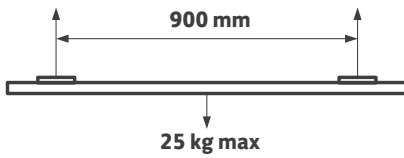

2 m Track

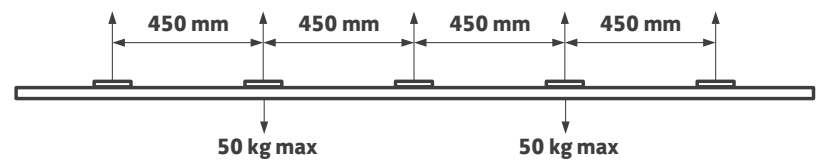
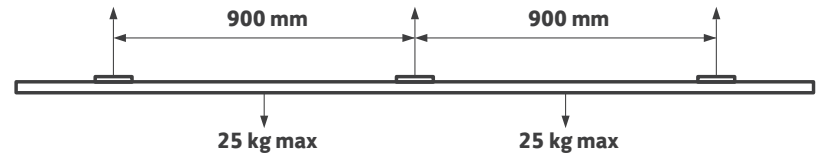

Layout Example

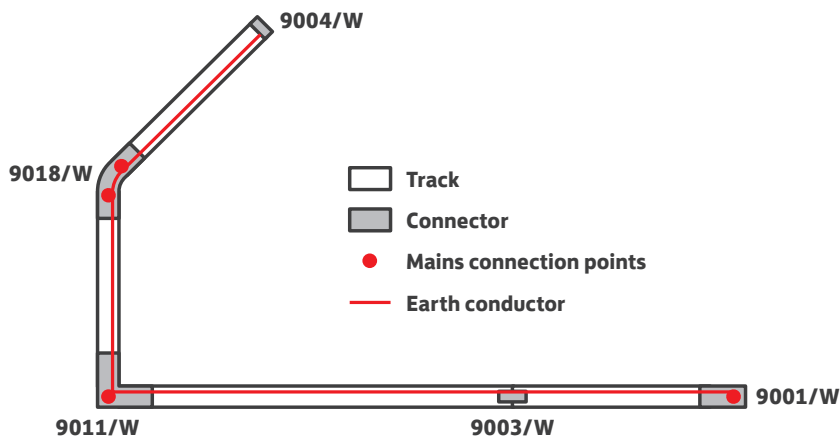

Electrical Connections

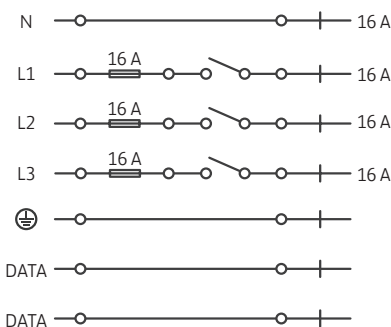
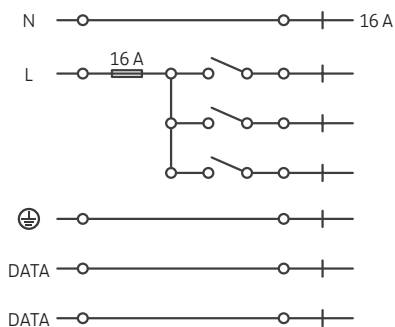

STUCCHI® ONETRACK®

DATASHEET

GAMMA
ILLUMINATION

Thornhill Road Business Park
Tenter Fields, Dewsbury
West Yorkshire
WF12 9QT
+44 (0)1924 482777
www.gamma-uk.com



FS 593079